

8-BIT ADDRESSABLE LATCH

FEATURES

- Combines demultiplexer and 8-bit latch
- Serial-to-parallel capability
- Output from each storage bit available
- Random (addressable) data entry
- Easily expandable
- Common reset input
- Useful as a 3-to-8 active HIGH decoder
- Output capability: standard
- I_{CC} category: MSI

GENERAL DESCRIPTION

The 74HC/HCT259 are high-speed Si-gate CMOS devices and are pin compatible with low power Schottky TTL (LSTTL). They are specified in compliance with JEDEC standard no. 7A.

The 74HC/HCT259 are high-speed 8-bit addressable latches designed for general purpose storage applications in digital systems. The "259" are multifunctional devices capable of storing single-line data in eight addressable latches, and also 3-to-8 decoder and demultiplexer, with active HIGH outputs (Q₀ to Q₇), functions are available.

The "259" also incorporates an active LOW common reset (MR) for resetting all latches, as well as, an active LOW enable input (LE).

(continued on next page)

SYMBOL	PARAMETER	CONDITIONS	TYPICAL		UNIT
			HC	HCT	
t _{PHL} / t _{PLH}	propagation delay D to Q _n A _n , LE to Q _n	C _L = 15 pF V _{CC} = 5 V	18 17	20 20	ns
t _{PHL}	MR to Q _n		15	20	ns
C _I	input capacitance		3.5	3.5	pF
CPD	power dissipation capacitance per latch	notes 1 and 2	19	19	pF

GND = 0 V; T_{amb} = 25 °C; t_r = t_f = 6 ns

Notes

1. CPD is used to determine the dynamic power dissipation (P_D in μW):

$$P_D = CPD \times V_{CC}^2 \times f_i + \sum (C_L \times V_{CC}^2 \times f_o) \text{ where:}$$

f_i = input frequency in MHz C_L = output load capacitance in pF
f_o = output frequency in MHz V_{CC} = supply voltage in V
Σ (C_L × V_{CC}² × f_o) = sum of outputs

2. For HC the condition is V_I = GND to V_{CC}
For HCT the condition is V_I = GND to V_{CC} - 1.5 V

PACKAGE OUTLINES

16-lead DIL; plastic (SOT38Z).

16-lead mini-pack; plastic (SO16; SOT109A).

PIN DESCRIPTION

PIN NO.	SYMBOL	NAME AND FUNCTION
1, 2, 3	A ₀ to A ₂	address inputs
4, 5, 6, 7, 9 10, 11, 12	Q ₀ to Q ₇	latch outputs
8	GND	ground (0 V)
13	D	data input
14	LE	latch enable input (active LOW)
15	MR	conditional reset input (active LOW)
16	V _{CC}	positive supply voltage

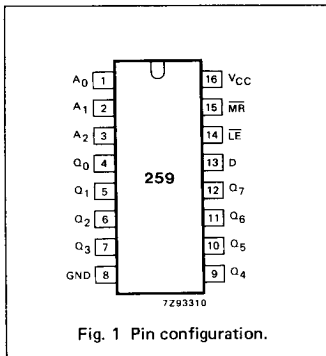

Fig. 1 Pin configuration.

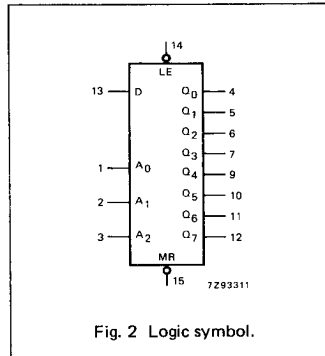

Fig. 2 Logic symbol.

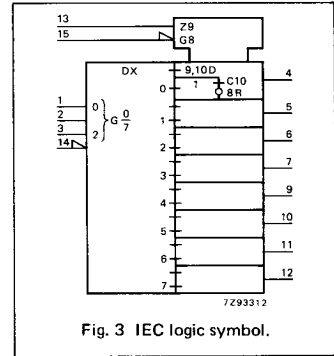

Fig. 3 IEC logic symbol.

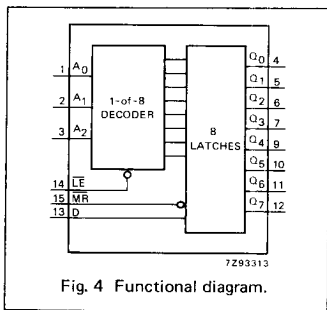

Fig. 4 Functional diagram.

GENERAL DESCRIPTION

The "259" has four modes of operation as shown in the mode select table. In the addressable latch mode, data on the data line (D) is written into the addressed latch. The addressed latch will follow the data input with all non-addressed latches remaining in their previous states. In the memory mode, all latches remain in their previous states and are unaffected by the data or address inputs.

In the 3-to-8 decoding or demultiplexing mode, the addressed output follows the state of the D input with all other outputs in the LOW state. In the reset mode all outputs are LOW and unaffected by the address (A₀ to A₂) and data (D) input. When operating the "259" as an addressable latch, changing more than one bit of address could impose a transient-wrong address. Therefore, this should only be done while in the memory mode. The mode select table summarizes the operations of the "259".

MODE SELECT TABLE

LE	MR	MODE
L	H	addressable latch
H	H	memory
L	L	active HIGH 8-channel demultiplexer
H	L	reset

FUNCTION TABLE

OPERATING MODES	INPUTS						OUTPUTS							
	MR	LE	D	A ₀	A ₁	A ₂	Q ₀	Q ₁	Q ₂	Q ₃	Q ₄	Q ₅	Q ₆	Q ₇
master reset	L	H	X	X	X	X	L	L	L	L	L	L	L	L
demultiplex (active HIGH) decoder (when D = H)	L	L	d	L	L	L	Q=d	L	L	L	L	L	L	L
	L	L	d	H	L	L	L	Q=d	L	L	L	L	L	L
	L	L	d	L	H	L	L	L	Q=d	L	L	L	L	L
	L	L	d	H	H	L	L	L	L	Q=d	L	L	L	L
	L	L	d	L	H	H	L	L	L	L	Q=d	L	L	L
	L	L	d	H	H	H	L	L	L	L	L	Q=d	L	L
store (do nothing)	H	H	X	X	X	X	q ₀	q ₁	q ₂	q ₃	q ₄	q ₅	q ₆	q ₇
addressable latch	H	L	d	L	L	L	Q=d	q ₁	q ₂	q ₃	q ₄	q ₅	q ₆	q ₇
	H	L	d	H	L	L	q ₀	Q=d	q ₂	q ₃	q ₄	q ₅	q ₆	q ₇
	H	L	d	L	H	L	q ₀	q ₁	Q=d	q ₃	q ₄	q ₅	q ₆	q ₇
	H	L	d	H	H	L	q ₀	q ₁	q ₂	Q=d	q ₄	q ₅	q ₆	q ₇
	H	L	d	L	L	H	q ₀	q ₁	q ₂	q ₃	Q=d	q ₅	q ₆	q ₇
	H	L	d	H	H	H	q ₀	q ₁	q ₂	q ₃	q ₄	Q=d	q ₆	q ₇

H = HIGH voltage level
L = LOW voltage level
X = don't care
d = HIGH or LOW data one set-up time prior to the LOW-to-HIGH LE transition
q = lower case letters indicate the state of the referenced output established during the last cycle in which it was addressed or cleared

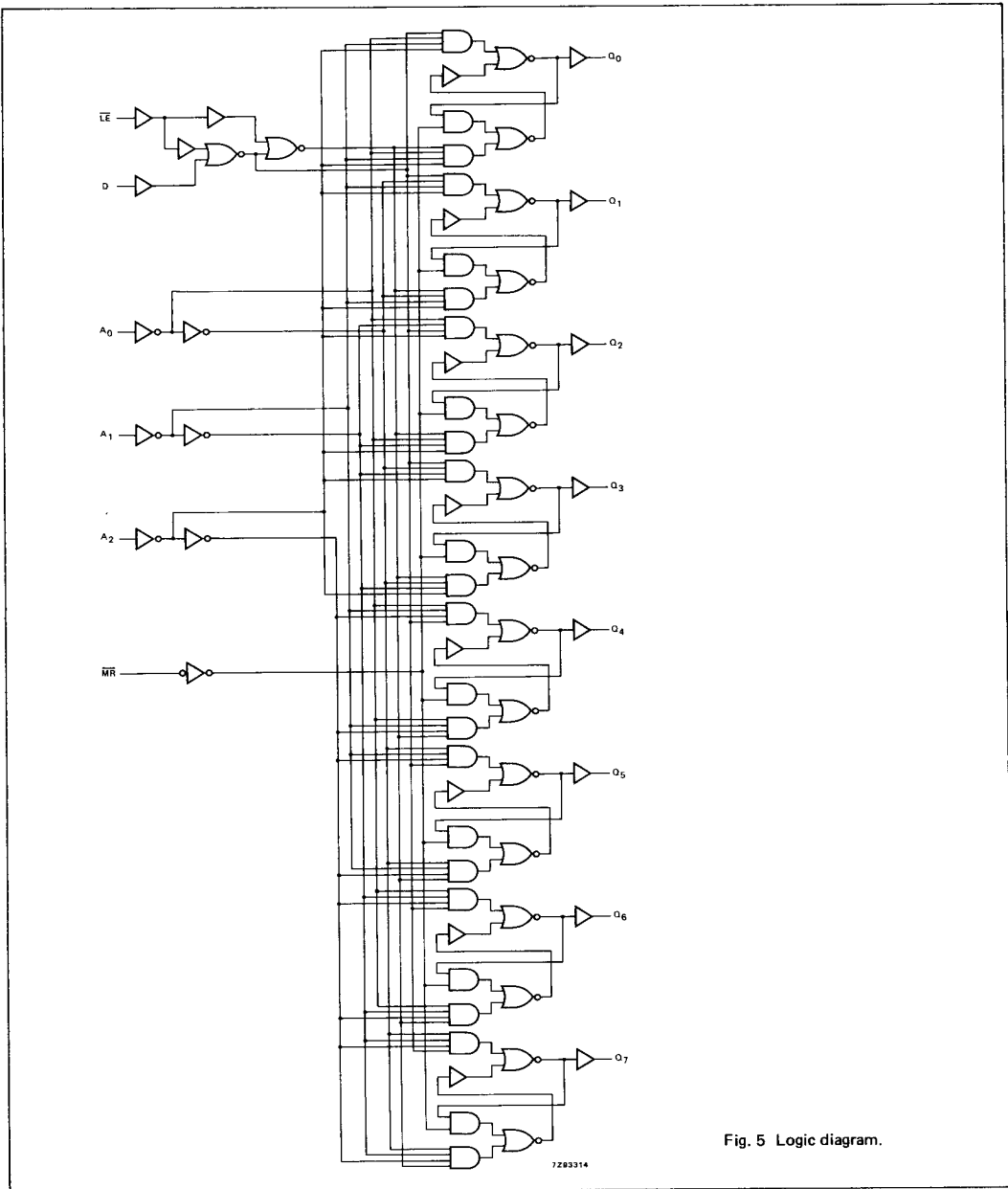

DC CHARACTERISTICS FOR 74HC

For the DC characteristics see chapter "HCMOS family characteristics", section "Family specifications".

Output capability: standard

I_{CC} category: MSI

AC CHARACTERISTICS FOR 74HC

GND = 0 V; t_r = t_f = 6 ns; C_L = 50 pF

SYMBOL	PARAMETER	T _{amb} (°C)						UNIT	TEST CONDITIONS		
		74HC							V _{CC} V	WAVEFORMS	
		+25			-40 to +85		-40 to +125				
		min.	typ.	max.	min.	max.	min.				max.
t _{PHL} / t _{PLH}	propagation delay D to Q _n		58 21 17	185 37 31		230 46 39		280 56 48	ns	2.0 4.5 6.0	Fig. 7
t _{PHL} / t _{PLH}	propagation delay A _n to Q _n		58 21 17	185 37 31		230 46 39		280 56 48	ns	2.0 4.5 6.0	Fig. 8
t _{PHL} / t _{PLH}	propagation delay LE to Q _n		55 20 16	170 34 29		215 43 37		255 51 43	ns	2.0 4.5 6.0	Fig. 6
t _{PHL}	propagation delay MR to Q _n		50 18 14	155 31 26		195 39 33		235 47 40	ns	2.0 4.5 6.0	Fig. 9
t _{THL} / t _{TLH}	output transition time		19 7 6	75 15 13		95 19 16		119 22 19	ns	2.0 4.5 6.0	Figs 6 and 7
t _W	LE pulse width HIGH or LOW	70 14 12	17 6 5		90 18 15		105 21 18		ns	2.0 4.5 6.0	Fig. 6
t _W	MR pulse width LOW	70 14 12	17 6 5		90 18 15		105 21 18		ns	2.0 4.5 6.0	Fig. 9
t _{su}	set-up time D, A _n to LE	80 16 14	19 7 6		100 20 17		120 24 20		ns	2.0 4.5 6.0	Figs 10 and 11
t _h	hold time D to LE	0 0 0	-19 -6 -5		0 0 0		0 0 0		ns	2.0 4.5 6.0	Fig. 10
t _h	hold time A _n to LE	2 2 2	-11 -4 -3		2 2 2		2 2 2		ns	2.0 4.5 6.0	Fig. 11

DC CHARACTERISTICS FOR 74HCT

For the DC characteristics see chapter "HCMOS family characteristics", section "Family specifications".

Output capability: standard

I_{CC} category: MSI

Note to HCT types

The value of additional quiescent supply current (ΔI_{CC}) for a unit load of 1 is given in the family specifications. To determine ΔI_{CC} per input, multiply this value by the unit load coefficient shown in the table below.

INPUT	UNIT LOAD COEFFICIENT
$\overline{A_n}$	1.50
\overline{LE}	1.50
\overline{D}	1.20
\overline{MR}	0.75

AC CHARACTERISTICS FOR 74HCT

GND = 0 V; $t_r = t_f = 6$ ns; $C_L = 50$ pF

SYMBOL	PARAMETER	T _{amb} (°C)						UNIT	TEST CONDITIONS		
		74HCT							V _{CC} V	WAVEFORMS	
		+25			-40 to +85		-40 to +125				
		min.	typ.	max.	min.	max.	min.				max.
t _{PHL} / t _{PLH}	propagation delay D to Q _n		23	39		49		59	ns	4.5	Fig. 7
t _{PHL} / t _{PLH}	propagation delay A _n to Q _n		25	41		51		62	ns	4.5	Fig. 8
t _{PHL} / t _{PLH}	propagation delay LE to Q _n		22	38		48		57	ns	4.5	Fig. 6
t _{PHL}	propagation delay MR to Q _n		23	39		49		59	ns	4.5	Fig. 9
t _{THL} / t _{TLH}	output transition time		7	15		19		22	ns	4.5	Figs 6 and 7
t _W	\overline{LE} pulse width LOW	19	11		24		29		ns	4.5	Fig. 6
t _W	\overline{MR} pulse width LOW	18	10		23		27		ns	4.5	Fig. 9
t _{su}	set-up time D to LE	17	10		21		26		ns	4.5	Fig. 10
t _{su}	set-up time A _n to LE	17	10		21		26		ns	4.5	Fig. 11
t _h	hold time D to LE	0	-8		0		0		ns	4.5	Fig. 10
t _h	hold time A _n to LE	0	-4		0		0		ns	4.5	Fig. 11

AC WAVEFORMS

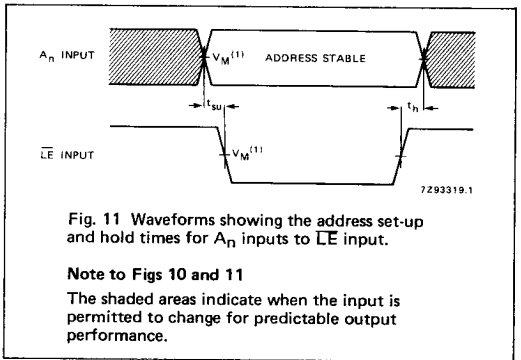
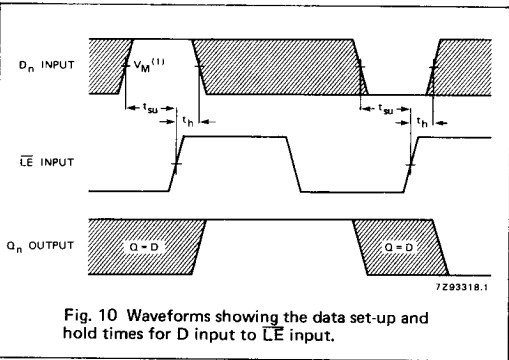
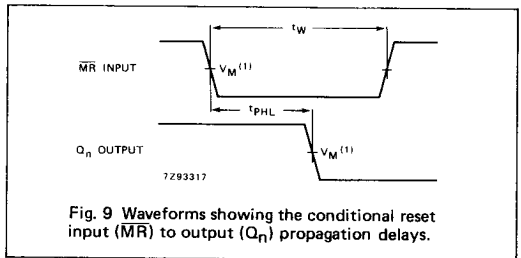
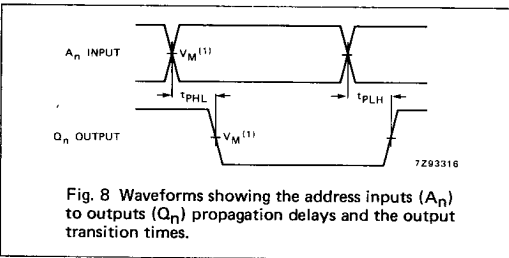
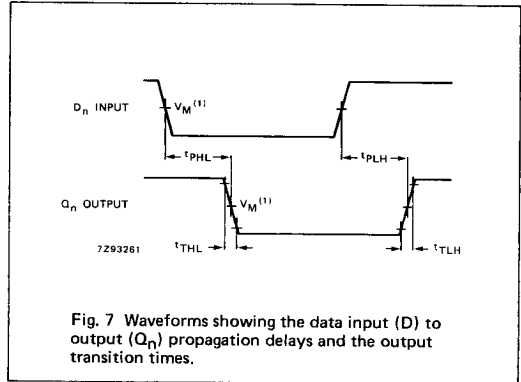
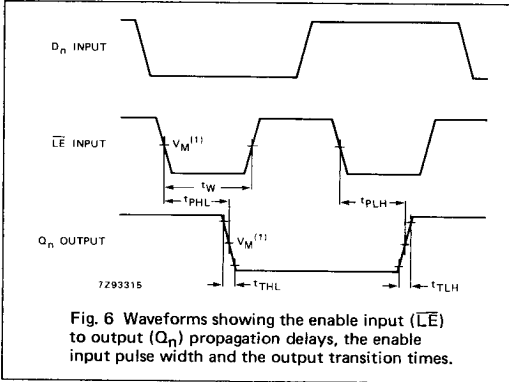

Note to AC waveforms

(1) HC : $V_M = 50\%$; $V_1 = \text{GND to } V_{CC}$.
HCT: $V_M = 1.3\text{V}$; $V_1 = \text{GND to } 3\text{V}$.